

CIRCUIT SIZE	DIM. "A"	DIM. "B"
6	.54 (13.8)	.33 (8.4)
8	.71 (18.0)	.50 (12.6)
10	.87 (22.2)	.66 (16.8)
12	1.04 (26.4)	.83 (21.0)
14	1.20 (30.6)	.99 (25.2)
16	1.37 (34.8)	1.16 (29.4)
18	1.54 (39.0)	1.32 (33.6)
20	1.70 (43.2)	1.49 (37.8)
22	1.87 (47.4)	1.65 (42.0)
24	2.03 (51.6)	1.82 (46.2)

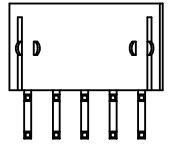

5569-AA2\*

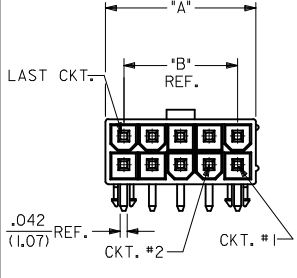
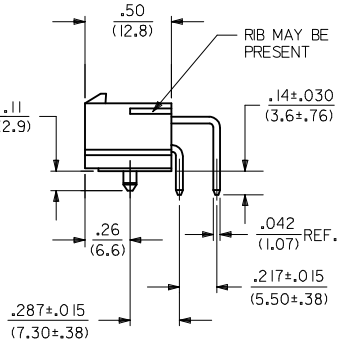
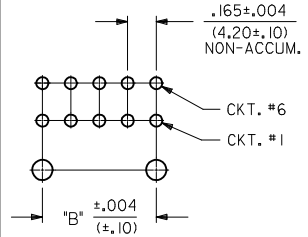

RECOMMENDED HOLE LAYOUT FOR .070(1.78) MAX. THICK P.C. BOARD VIEWED FROM COMPONENT SIDE

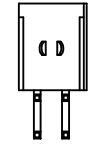
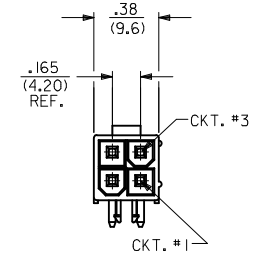

5569-04A2\*

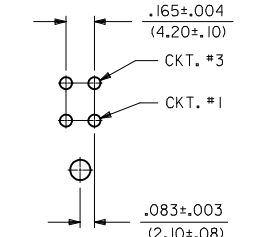

RECOMMENDED HOLE LAYOUT FOR .070(1.78) MAX. THICK P.C. BOARD VIEWED FROM COMPONENT SIDE

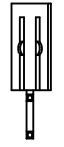
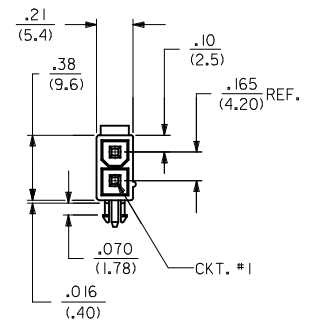

5569-02A2\*

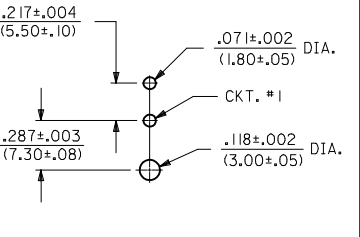

RECOMMENDED HOLE LAYOUT FOR .070(1.78) MAX. THICK P.C. BOARD VIEWED FROM COMPONENT SIDE

- NOTES:**
- MATERIAL:**  
HOUSING:  
"BLANK" = NYLON (PA66), UNFILLED, UL94V-2, COLOR: NATURAL  
"100" = NYLON (PA66), UNFILLED, UL94V-2, COLOR: BLACK  
"BL" = NYLON (PA66), UNFILLED, UL94V-2, COLOR: BLACK  
"210" = NYLON (PA66), UNFILLED, UL94V-0, COLOR: NATURAL  
"400" = NYLON (PA66), UNFILLED, UL94V-0, COLOR: BLACK  
TERMINAL:  
BRASS ALLOY
  - FINISH (PLATING):**  
"BLANK" = .000200/(0.00508) MIN. BRIGHT TIN OVER  
.000100/(0.00254) MIN. COPPER  
"G" = .000030/(0.00076) MIN. GOLD OVER  
.000050/(0.00127) MIN. NICKEL  
"G2" = .000015/(0.00038) MIN. GOLD OVER  
.000030/(0.00076) MIN. NICKEL  
"G3" = .000050/(0.00127) MIN. GOLD OVER  
.000050/(0.00127) MIN. NICKEL  
"GS" = .000030/(0.00076) MIN. SELECT GOLD OVER  
.000100/(0.00254) MIN. SELECT MATTE TIN  
OVER .000050/(0.00127) MIN. NICKEL OVERALL  
"GS2" = .000015/(0.00038) MIN. SELECT GOLD OVER  
.000100/(0.00254) MIN. SELECT MATTE TIN  
OVER .000050/(0.00127) MIN. NICKEL OVERALL  
"GS3" = .000050/(0.00127) MIN. SELECT GOLD OVER  
.000100/(0.00254) MIN. SELECT MATTE TIN  
OVER .000050/(0.00127) MIN. NICKEL OVERALL  
"S" = .000100/(0.00254) MIN. BRIGHT TIN OVER  
.000050/(0.00127) MIN. NICKEL  
\*THE PRIMARY SHIPPING CARTON WILL BE LABELED "COMPLIANT TO RoHS DIRECTIVE 2002/95/EC AND ELV ANNEX II OF DIRECTIVE 2000/53/EC". CARTONS WITHOUT THIS LABEL MAY CONTAIN PRODUCT WITH TIN-LEAD PLATING.

- PRODUCT SPECIFICATION: SHOWN IN CHART AT RIGHT
- PACKAGING:  
"BLANK" = BULK PACKED PER PK-5569-002  
"T" = TRAY PACKED PER PK-5569-003

- PART MATES WITH MINI-FIT JR. RECEPTACLE SERIES 5557.
- MOUNTING OPTIONS:  
1 = SCREW MOUNT (SEE SD-5569-NA\* SERIES DRAWING)  
2 = PEG MOUNT
- DISCOLORATION IN THE BANDOLIER CARRIER AREA OF THE PIN IS INHERENT TO THE PLATING PROCESS AND IS DUE TO THE MASKING EFFECT OF THE CARRIER. THIS DISCOLORATION IS IN A NON-FUNCTIONAL AREA OF THE PIN AND WILL NOT AFFECT THE PERFORMANCE OF THE HEADER ASSEMBLY.
- PART CONFORMS TO CLASS "B" REQUIREMENTS OF COSMETIC SPECIFICATION PS-45499-002.
- CONNECTORS ARE NOT TO BE MATED AND UNMATED WHILE CIRCUITS ARE LIVE.
- PARTS ARE NOT DESIGNED FOR CURRENT SHARING.

5569-AA2S-BL	PS-5556-001
5569-AA2G3-BL	PS-5556-001
5569-AA2G2-BL	PS-5556-001
5569-AA2G-BL	PS-5556-001
5569-AA2-BL	PS-5556-001
5569-AA2G3 & -AA2G3-210	PS-5556-001
5569-AA2S & -AA2S-210	PS-5556-001
5569-AA2GS3 & -AA2GS3-210	PS-5556-001
5569-AA2GS2 & -AA2GS2-210	PS-5556-001
5569-AA2GS & -AA2GS-210	PS-5556-001
5569-AA2G2 & -AA2G2-210	PS-5556-001
5569-AA2G & -AA2G-210	PS-5556-001
5569-AA2 & -AA2-210	PS-5556-001

2-6	GENERAL DOCS.	L
1	MEIO	L1
SHT.	SOFTWARE	REV.

PRODUCT SPEC. CHART

ENG. NO.	PROD. SPEC. NO.
----------	-----------------

CORRECTED DIMENSION EC NO: UCP2009-0576 DRAWN: JKLOSTNER/ER2008/10/07 CHKD: JBELL 2008/10/08 APPR: FSMITH 2008/10/08	QUALITY SYMBOLS
	GENERAL TOLERANCES (UNLESS SPECIFIED)
	DIMENSION STYLE
	SCALE

4 PLACES ± --- ± ---	3 PLACES ± --- ± .010	2 PLACES ± .25 ± .015	1 PLACE ± .38 ± ---
ANGULAR ±1/2°			
DRAFT WHERE APPLICABLE MUST REMAIN WITHIN DIMENSIONS			

DRAWN BY	DATE
CHECKED BY	DATE
APPROVED BY	DATE
MATERIAL NO.	DOCUMENT NO.

SCALE: 4:1 DESIGN UNITS: METRIC THIRD ANGLE PROJECTION

**MINI-FIT JR RIGHT ANGLE HEADER ASSEMBLIES WITH MOUNTING PEGS**

**MOLEX INCORPORATED**

SEE CHART SDA-5569-NA2\*-\* SHEET NO. 1 OF 6

THIS DRAWING CONTAINS INFORMATION THAT IS PROPRIETARY TO MOLEX INCORPORATED AND SHOULD NOT BE USED WITHOUT WRITTEN PERMISSION

**BULK PACKAGED PER PK-5569-002**

PART NUMBER	ENG. NUMBER	CKT. SIZE	PLATING (NOTE 2)	HSG MAT'L	PART NUMBER	ENG. NUMBER	CKT. SIZE	PLATING (NOTE 2)	HSG MAT'L
39-30-1020	5569-02A2	2	TIN OVER COPPER SEE NOTE 2 OPTION "BLANK"	94V-2	39-30-0020	5569-02A2-210	2	TIN OVER COPPER SEE NOTE 2 OPTION "BLANK"	94V-0
39-30-1040	5569-04A2	4			39-30-0040	5569-04A2-210	4		
39-30-1060	5569-06A2	6			39-30-0060	5569-06A2-210	6		
39-30-1080	5569-08A2	8			39-30-0080	5569-08A2-210	8		
39-30-1100	5569-10A2	10			39-30-0100	5569-10A2-210	10		
39-30-1120	5569-12A2	12			39-30-0120	5569-12A2-210	12		
39-30-1140	5569-14A2	14			39-30-0140	5569-14A2-210	14		
39-30-1160	5569-16A2	16			39-30-0160	5569-16A2-210	16		
39-30-1180	5569-18A2	18			39-30-0180	5569-18A2-210	18		
39-30-1200	5569-20A2	20			39-30-0200	5569-20A2-210	20		
39-30-1220	5569-22A2	22			39-30-0220	5569-22A2-210	22		
39-30-1240	5569-24A2	24			39-30-0240	5569-24A2-210	24		

39-30-1021	5569-02A2G	2	30 μ" GOLD SEE NOTE 2 OPTION "G"	94V-2	39-30-1022	5569-02A2G-210	2	30 μ" GOLD SEE NOTE 2 OPTION "G"	94V-0
39-30-1041	5569-04A2G	4			39-30-1042	5569-04A2G-210	4		
39-30-1061	5569-06A2G	6			39-30-1062	5569-06A2G-210	6		
39-30-1081	5569-08A2G	8			39-30-1082	5569-08A2G-210	8		
39-30-1101	5569-10A2G	10			39-30-1102	5569-10A2G-210	10		
39-30-1121	5569-12A2G	12			39-30-1122	5569-12A2G-210	12		
39-30-1141	5569-14A2G	14			39-30-1142	5569-14A2G-210	14		
39-30-1161	5569-16A2G	16			39-30-1162	5569-16A2G-210	16		
39-30-1181	5569-18A2G	18			39-30-1182	5569-18A2G-210	18		
39-30-1201	5569-20A2G	20			39-30-1202	5569-20A2G-210	20		
39-30-1221	5569-22A2G	22			39-30-1222	5569-22A2G-210	22		
39-30-1241	5569-24A2G	24			39-30-1242	5569-24A2G-210	24		

39-30-0021	5569-02A2G2	2	15 μ" GOLD SEE NOTE 2 OPTION "G2"	94V-2	39-30-0022	5569-02A2G2-210	2	15 μ" GOLD SEE NOTE 2 OPTION "G2"	94V-0
39-30-0041	5569-04A2G2	4			39-30-0042	5569-04A2G2-210	4		
39-30-0061	5569-06A2G2	6			39-30-0062	5569-06A2G2-210	6		
39-30-0081	5569-08A2G2	8			39-30-0082	5569-08A2G2-210	8		
39-30-0101	5569-10A2G2	10			39-30-0102	5569-10A2G2-210	10		
39-30-0121	5569-12A2G2	12			39-30-0122	5569-12A2G2-210	12		
39-30-0141	5569-14A2G2	14			39-30-0142	5569-14A2G2-210	14		
39-30-0161	5569-16A2G2	16			39-30-0162	5569-16A2G2-210	16		
39-30-0181	5569-18A2G2	18			39-30-0182	5569-18A2G2-210	18		
39-30-0201	5569-20A2G2	20			39-30-0202	5569-20A2G2-210	20		
39-30-0221	5569-22A2G2	22			39-30-0222	5569-22A2G2-210	22		
39-30-0241	5569-24A2G2	24			39-30-0242	5569-24A2G2-210	24		

NOT TOOLED	5569-02A2G3	2	50 μ" GOLD SEE NOTE 2 OPTION "G3"	94V-2	NOT TOOLED	5569-02A2G3-210	2	50 μ" GOLD SEE NOTE 2 OPTION "G3"	94V-0
15-27-1514	5569-04A2G3	4			NOT TOOLED	5569-04A2G3-210	4		
15-27-1511	5569-06A2G3	6			NOT TOOLED	5569-06A2G3-210	6		
15-27-1512	5569-08A2G3	8			NOT TOOLED	5569-08A2G3-210	8		
15-27-1503	5569-10A2G3	10			15-27-1504	5569-10A2G3-210	10		
NOT TOOLED	5569-12A2G3	12			NOT TOOLED	5569-12A2G3-210	12		
NOT TOOLED	5569-14A2G3	14			NOT TOOLED	5569-14A2G3-210	14		
15-27-1513	5569-16A2G3	16			NOT TOOLED	5569-16A2G3-210	16		
NOT TOOLED	5569-18A2G3	18			NOT TOOLED	5569-18A2G3-210	18		
NOT TOOLED	5569-20A2G3	20			NOT TOOLED	5569-20A2G3-210	20		
NOT TOOLED	5569-22A2G3	22			NOT TOOLED	5569-22A2G3-210	22		
NOT TOOLED	5569-24A2G3	24			NOT TOOLED	5569-24A2G3-210	24		

<b>REVISION:</b>  <b>L</b>	<b>ECR/ECN INFORMATION:</b>  EC No: <b>UCP2007-2432</b>  DATE: <b>2007/04/02</b>	<b>TITLE:</b>  <b>MINI-FIT JR.® RIGHT ANGLE HEADER ASSEMBLIES WITH MOUNTING PEGS</b>	<b>SHEET No.</b>  - 2 -
----------------------------------	--	--	-------------------------------

<b>DOCUMENT NUMBER:</b> <b>SDA-5569-NA2*-*</b>	<b>Drawn By:</b> <b>LSCHMIDT</b>	<b>Checked By:</b> <b>ADERR</b>	<b>Approved By:</b> <b>FSMITH</b>
---	-------------------------------------	------------------------------------	--------------------------------------

**BULK PACKAGED PK-5569-002**

PART NUMBER	ENG. NUMBER	CKT. SIZE	PLATING (NOTE 2)	HSG MAT'L	PART NUMBER	ENG. NUMBER	CKT. SIZE	PLATING (NOTE 2)	HSG MAT'L
39-30-0023	5569-02A2GS	2	30 μ" SELECT GOLD SEE NOTE 2 OPTION "GS"	94V-2	39-30-0024	5569-02A2GS-210	2	30 μ" SELECT GOLD SEE NOTE 2 OPTION "GS"	94V-0
39-30-0043	5569-04A2GS	4			39-30-0044	5569-04A2GS-210	4		
39-30-0063	5569-06A2GS	6			39-30-0064	5569-06A2GS-210	6		
39-30-0083	5569-08A2GS	8			39-30-0084	5569-08A2GS-210	8		
39-30-0103	5569-10A2GS	10			39-30-0104	5569-10A2GS-210	10		
39-30-0123	5569-12A2GS	12			39-30-0124	5569-12A2GS-210	12		
39-30-0143	5569-14A2GS	14			39-30-0144	5569-14A2GS-210	14		
39-30-0163	5569-16A2GS	16			39-30-0164	5569-16A2GS-210	16		
39-30-0183	5569-18A2GS	18			39-30-0184	5569-18A2GS-210	18		
39-30-0203	5569-20A2GS	20			39-30-0204	5569-20A2GS-210	20		
39-30-0223	5569-22A2GS	22			39-30-0224	5569-22A2GS-210	22		
39-30-0243	5569-24A2GS	24			39-30-0244	5569-24A2GS-210	24		

39-30-1023	5569-02A2GS2	2	15 μ" SELECT GOLD SEE NOTE 2 OPTION "GS2"	94V-2	39-30-1024	5569-02A2GS2-210	2	15 μ" SELECT GOLD SEE NOTE 2 OPTION "GS2"	94V-0
39-30-1043	5569-04A2GS2	4			39-30-1044	5569-04A2GS2-210	4		
39-30-1063	5569-06A2GS2	6			39-30-1064	5569-06A2GS2-210	6		
39-30-1083	5569-08A2GS2	8			39-30-1084	5569-08A2GS2-210	8		
39-30-1103	5569-10A2GS2	10			39-30-1104	5569-10A2GS2-210	10		
39-30-1123	5569-12A2GS2	12			39-30-1124	5569-12A2GS2-210	12		
39-30-1143	5569-14A2GS2	14			39-30-1144	5569-14A2GS2-210	14		
39-30-1163	5569-16A2GS2	16			39-30-1164	5569-16A2GS2-210	16		
39-30-1183	5569-18A2GS2	18			39-30-1184	5569-18A2GS2-210	18		
39-30-1203	5569-20A2GS2	20			39-30-1204	5569-20A2GS2-210	20		
39-30-1223	5569-22A2GS2	22			39-30-1224	5569-22A2GS2-210	22		
39-30-1243	5569-24A2GS2	24			39-30-1244	5569-24A2GS2-210	24		

39-34-4026	5569-02A2GS3	2	50 μ" SELECT GOLD SEE NOTE 2 OPTION "GS3"	94V-2	39-34-4027	5569-02A2GS3-210	2	50 μ" SELECT GOLD SEE NOTE 2 OPTION "GS3"	94V-2
39-34-4046	5569-04A2GS3	4			39-34-4047	5569-04A2GS3-210	4		
NOT TOOLED	5569-06A2GS3	6			NOT TOOLED	5569-06A2GS3-210	6		
NOT TOOLED	5569-08A2GS3	8			NOT TOOLED	5569-08A2GS3-210	8		
NOT TOOLED	5569-10A2GS3	10			NOT TOOLED	5569-10A2GS3-210	10		
NOT TOOLED	5569-12A2GS3	12			NOT TOOLED	5569-12A2GS3-210	12		
NOT TOOLED	5569-14A2GS3	14			NOT TOOLED	5569-14A2GS3-210	14		
NOT TOOLED	5569-16A2GS3	16			NOT TOOLED	5569-16A2GS3-210	16		
NOT TOOLED	5569-18A2GS3	18			NOT TOOLED	5569-18A2GS3-210	18		
NOT TOOLED	5569-20A2GS3	20			NOT TOOLED	5569-20A2GS3-210	20		
NOT TOOLED	5569-22A2GS3	22			NOT TOOLED	5569-22A2GS3-210	22		
NOT TOOLED	5569-24A2GS3	24			NOT TOOLED	5569-24A2GS3-210	24		

39-30-7025	5569-02A2S	2	TIN OVER NICKEL SEE NOTE 2 OPTION "S"	94V-2	39-30-7026	5569-02A2S-210	2	TIN OVER NICKEL SEE NOTE 2 OPTION "S"	94V-0
39-30-7045	5569-04A2S	4			39-30-7046	5569-04A2S-210	4		
39-30-7065	5569-06A2S	6			39-30-7066	5569-06A2S-210	6		
39-30-7085	5569-08A2S	8			39-30-7086	5569-08A2S-210	8		
39-30-7105	5569-10A2S	10			39-30-7106	5569-10A2S-210	10		
39-30-7125	5569-12A2S	12			39-30-7126	5569-12A2S-210	12		
39-30-7145	5569-14A2S	14			39-30-7146	5569-14A2S-210	14		
39-30-7165	5569-16A2S	16			39-30-7166	5569-16A2S-210	16		
39-30-7185	5569-18A2S	18			39-30-7186	5569-18A2S-210	18		
39-30-7205	5569-20A2S	20			39-30-7206	5569-20A2S-210	20		
39-30-7225	5569-22A2S	22			39-30-7226	5569-22A2S-210	22		
39-30-7245	5569-24A2S	24			39-30-7246	5569-24A2S-210	24		

<b>REVISION:</b>  <b>L</b>	<b>ECR/ECN INFORMATION:</b>  EC No: <b>UCP2007-2432</b>  DATE: <b>2007/04/02</b>	<b>TITLE:</b>  <b>MINI-FIT JR.® RIGHT ANGLE HEADER ASSEMBLIES WITH MOUNTING PEGS</b>	<b>SHEET No.</b>  - 3 -
----------------------------------	--	--	-------------------------------

<b>DOCUMENT NUMBER:</b>  <b>SDA-5569-NA2*-*</b>	<b>Drawn By:</b>  <b>LSCHMIDT</b>	<b>Checked By:</b>  <b>ADERR</b>	<b>Approved By:</b>  <b>FSMITH</b>
---	---	--	--

**BULK PACKAGED PER PK-5569-002**

PART NUMBER	ENG. NUMBER	CKT. SIZE	PLATING (NOTE 2)	HSG MAT'L	PART NUMBER	ENG. NUMBER	CKT. SIZE	PLATING (NOTE 2)	HSG MAT'L
39-34-9022	5569-02A2-100	2	TIN OVER COPPER SEE NOTE 2 OPTION "BLANK"	94V-2	39-31-1021	5569-02A2-BL	2	TIN OVER COPPER SEE NOTE 2 OPTION "BLANK"	94V-2
39-34-9042	5569-04A2-100	4			39-31-1041	5569-04A2-BL	4		
39-34-9064	5569-06A2-100	6			39-31-1061	5569-06A2-BL	6		
39-34-9084	5569-08A2-100	8			39-31-1081	5569-08A2-BL	8		
39-34-9104	5569-10A2-100	10			39-31-1101	5569-10A2-BL	10		
39-34-9124	5569-12A2-100	12			39-31-1121	5569-12A2-BL	12		
39-34-9144	5569-14A2-100	14			39-31-1141	5569-14A2-BL	14		
39-34-9164	5569-16A2-100	16			39-31-1161	5569-16A2-BL	16		
39-34-9184	5569-18A2-100	18			39-31-1181	5569-18A2-BL	18		
39-34-9204	5569-20A2-100	20			39-31-1201	5569-20A2-BL	20		
39-34-9224	5569-22A2-100	22			39-31-1221	5569-22A2-BL	22		
39-34-9244	5569-24A2-100	24			39-31-1241	5569-24A2-BL	24		

39-34-9023	5569-02A2S-100	2	TIN OVER NICKEL SEE NOTE 2 OPTION "S"	94V-2	39-31-6029	5569-02A2G-BL	2	30 μ" GOLD SEE NOTE 2 OPTION "G"	94V-2
39-34-9043	5569-04A2S-100	4			39-31-6049	5569-04A2G-BL	4		
39-34-9063	5569-06A2S-100	6			39-31-6069	5569-06A2G-BL	6		
39-34-9083	5569-08A2S-100	8			39-31-6089	5569-08A2G-BL	8		
39-34-9103	5569-10A2S-100	10			39-31-6109	5569-10A2G-BL	10		
39-34-9123	5569-12A2S-100	12			39-31-6129	5569-12A2G-BL	12		
39-34-9143	5569-14A2S-100	14			39-31-6149	5569-14A2G-BL	14		
39-34-9163	5569-16A2S-100	16			39-31-6169	5569-16A2G-BL	16		
39-34-9183	5569-18A2S-100	18			39-31-6189	5569-18A2G-BL	18		
39-34-9203	5569-20A2S-100	20			39-31-6209	5569-20A2G-BL	20		
39-34-9223	5569-22A2S-100	22			39-31-6229	5569-22A2G-BL	22		
39-34-9243	5569-24A2S-100	24			39-31-6249	5569-24A2G-BL	24		

39-34-9020	5569-02A2-400	2	TIN OVER COPPER SEE NOTE 2 OPTION "BLANK"	94V-2	39-31-7020	5569-02A2G2-BL	2	15 μ" GOLD SEE NOTE 2 OPTION "G2"	94V-2
39-34-9040	5569-04A2-400	4			39-31-7040	5569-04A2G2-BL	4		
39-34-9060	5569-06A2-400	6			39-31-7060	5569-06A2G2-BL	6		
39-34-9080	5569-08A2-400	8			39-31-7080	5569-08A2G2-BL	8		
39-34-9100	5569-10A2-400	10			39-31-7100	5569-10A2G2-BL	10		
39-34-9120	5569-12A2-400	12			39-31-7120	5569-12A2G2-BL	12		
39-34-9140	5569-14A2-400	14			39-31-7140	5569-14A2G2-BL	14		
39-34-9160	5569-16A2-400	16			39-31-7160	5569-16A2G2-BL	16		
39-34-9180	5569-18A2-400	18			39-31-7180	5569-18A2G2-BL	18		
39-34-9200	5569-20A2-400	20			39-31-7200	5569-20A2G2-BL	20		
39-34-9220	5569-22A2-400	22			39-31-7220	5569-22A2G2-BL	22		
39-34-9240	5569-24A2-400	24			39-31-7240	5569-24A2G2-BL	24		

39-34-9021	5569-02A2S-400	2	TIN OVER NICKEL SEE NOTE 2 OPTION "S"	94V-2	39-31-7021	5569-02A2G3-BL	2	50 μ" GOLD SEE NOTE 2 OPTION "G3"	94V-2
39-34-9041	5569-04A2S-400	4			39-31-7041	5569-04A2G3-BL	4		
39-34-9061	5569-06A2S-400	6			39-31-7061	5569-06A2G3-BL	6		
39-34-9081	5569-08A2S-400	8			39-31-7081	5569-08A2G3-BL	8		
39-34-9101	5569-10A2S-400	10			39-31-7101	5569-10A2G3-BL	10		
39-34-9121	5569-12A2S-400	12			39-31-7121	5569-12A2G3-BL	12		
39-34-9141	5569-14A2S-400	14			39-31-7141	5569-14A2G3-BL	14		
39-34-9161	5569-16A2S-400	16			39-31-7161	5569-16A2G3-BL	16		
39-34-9181	5569-18A2S-400	18			39-31-7181	5569-18A2G3-BL	18		
39-34-9201	5569-20A2S-400	20			39-31-7201	5569-20A2G3-BL	20		
39-34-9221	5569-22A2S-400	22			39-31-7221	5569-22A2G3-BL	22		
39-34-9241	5569-24A2S-400	24			39-31-7241	5569-24A2G3-BL	24		

<b>REVISION:</b>  <b>L</b>	<b>ECR/ECN INFORMATION:</b>  EC No: <b>UCP2007-2432</b>  DATE: <b>2007/04/02</b>	<b>TITLE:</b>  <b>MINI-FIT JR.® RIGHT ANGLE HEADER ASSEMBLIES WITH MOUNTING PEGS</b>	<b>SHEET No.</b>  - 4 -
----------------------------------	--	--	-------------------------------

<b>DOCUMENT NUMBER:</b> <b>SDA-5569-NA2*-*</b>	<b>Drawn By:</b> <b>LSCHMIDT</b>	<b>Checked By:</b> <b>ADERR</b>	<b>Approved By:</b> <b>FSMITH</b>
---	-------------------------------------	------------------------------------	--------------------------------------

BULK PACKAGED PER PK-5569-002

PART NUMBER	ENG. NUMBER	CKT. SIZE	PLATING (NOTE 2)	HSG MAT'L	PART NUMBER	ENG. NUMBER	CKT. SIZE	PLATING (NOTE 2)	HSG MAT'L
					39-31-9029	5569-02A2S-BL	2	TIN OVER NICKEL SEE NOTE 2 OPTION "S"	94V-2
					39-31-9049	5569-04A2S-BL	4		
					39-31-9069	5569-06A2S-BL	6		
					39-31-9089	5569-08A2S-BL	8		
					39-31-9109	5569-10A2S-BL	10		
					39-31-9129	5569-12A2S-BL	12		
					39-31-9149	5569-14A2S-BL	14		
					39-31-9169	5569-16A2S-BL	16		
					39-31-9189	5569-18A2S-BL	18		
					39-31-9209	5569-20A2S-BL	20		
					39-31-9229	5569-22A2S-BL	22		
					39-31-9249	5569-24A2S-BL	24		



REVISION: <b>L</b>	ECR/ECN INFORMATION: EC No: <b>UCP2007-2432</b> DATE: <b>2007/04/02</b>	TITLE: <b>MINI-FIT JR.® RIGHT ANGLE HEADER ASSEMBLIES WITH MOUNTING PEGS</b>	SHEET No. <b>- 5 -</b>
--------------------	---	--	------------------------

DOCUMENT NUMBER: <b>SDA-5569-NA2*-*</b>	Drawn By: <b>LSCHMIDT</b>	Checked By: <b>ADERR</b>	Approved By: <b>FSMITH</b>
---	---------------------------	--------------------------	----------------------------

TRAY PACKAGED PER PK-5569-003

PART NUMBER	ENG. NUMBER	CKT. SIZE	PLATING (NOTE 2)	HSG MAT'L	PART NUMBER	ENG. NUMBER	CKT. SIZE	PLATING (NOTE 2)	HSG MAT'L
50-36-1757	5569-02A2S-T	2	TIN OVER NICKEL SEE NOTE 2 OPTION "S"	94V-2	50-36-1758	5569-02A2S-210-T	2	TIN OVER NICKEL SEE NOTE 2 OPTION "S"	94V-0
50-36-1767	5569-04A2S-T	4			50-36-1768	5569-04A2S-210-T	4		
50-36-1777	5569-06A2S-T	6			50-36-1778	5569-06A2S-210-T	6		
50-36-1787	5569-08A2S-T	8			50-36-1788	5569-08A2S-210-T	8		
50-36-1797	5569-10A2S-T	10			50-36-1798	5569-10A2S-210-T	10		
50-36-1807	5569-12A2S-T	12			50-36-1808	5569-12A2S-210-T	12		
50-36-1817	5569-14A2S-T	14			50-36-1818	5569-14A2S-210-T	14		
50-36-1827	5569-16A2S-T	16			50-36-1828	5569-16A2S-210-T	16		
50-36-1837	5569-18A2S-T	18			50-36-1838	5569-18A2S-210-T	18		
50-36-1847	5569-20A2S-T	20			50-36-1848	5569-20A2S-210-T	20		
50-36-1857	5569-22A2S-T	22			50-36-1858	5569-22A2S-210-T	22		
50-36-1867	5569-24A2S-T	24			50-36-1868	5569-24A2S-210-T	24		
50-36-1755	5569-02A2GS-T	2			30 μ" SELECT GOLD SEE NOTE 2 OPTION "GS"	94V-2	50-36-1756		
50-36-1765	5569-04A2GS-T	4	50-36-1766	5569-04A2GS-210-T			4		
50-36-1775	5569-06A2GS-T	6	50-36-1776	5569-06A2GS-210-T			6		
50-36-1785	5569-08A2GS-T	8	50-36-1786	5569-08A2GS-210-T			8		
50-36-1795	5569-10A2GS-T	10	50-36-1796	5569-10A2GS-210-T			10		
50-36-1805	5569-12A2GS-T	12	50-36-1806	5569-12A2GS-210-T			12		
50-36-1815	5569-14A2GS-T	14	50-36-1816	5569-14A2GS-210-T			14		
50-36-1825	5569-16A2GS-T	16	50-36-1826	5569-16A2GS-210-T			16		
50-36-1835	5569-18A2GS-T	18	50-36-1836	5569-18A2GS-210-T			18		
50-36-1845	5569-20A2GS-T	20	50-36-1846	5569-20A2GS-210-T			20		
50-36-1855	5569-22A2GS-T	22	50-36-1856	5569-22A2GS-210-T			22		
50-36-1865	5569-24A2GS-T	24	50-36-1866	5569-24A2GS-210-T			24		
		2						2	
		4				4			
		6				6			
		8				8			
		10				10			
		12				12			
		14				14			
		16				16			
		18				18			
		20				20			
		22				22			
		24				24			
		2				2			
		4				4			
		6				6			
		8				8			
		10				10			
		12				12			
		14				14			
		16				16			
		18				18			
		20				20			
		22				22			
		24				24			

REVISION: <b>L</b>	ECR/ECN INFORMATION: EC No: <b>UCP2007-2432</b> DATE: <b>2007/04/02</b>	TITLE: <b>MINI-FIT JR.® RIGHT ANGLE HEADER ASSEMBLIES WITH MOUNTING PEGS</b>	SHEET No. <b>- 6 -</b>
--------------------	--	--	------------------------

DOCUMENT NUMBER: <b>SDA-5569-NA2*-*</b>	Drawn By: <b>LSCHMIDT</b>	Checked By: <b>ADERR</b>	Approved By: <b>FSMITH</b>
---	---------------------------	--------------------------	----------------------------